

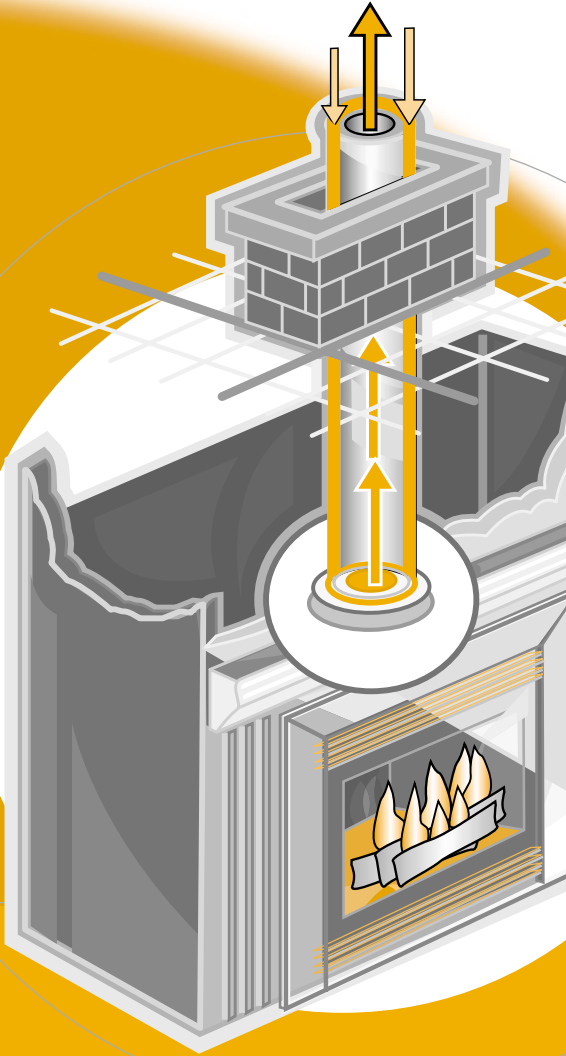

All About Gas Fireplaces



Natural Resources
Canada

Ressources naturelles
Canada

Canada



All About Gas Fireplaces

Produced by
Office of Energy Efficiency
Natural Resources Canada
EnerGuide

The Heating and Cooling Series is published by Natural Resources Canada's Office of Energy Efficiency. EnerGuide is the official Government of Canada mark associated with the labelling and rating of the energy consumption or energy efficiency of household appliances, heating and ventilation equipment, air conditioners, houses and vehicles.

EnerGuide also helps manufacturers and dealers promote energy-efficient equipment and provides consumers with the information they need to choose energy-efficient residential equipment.

EnerGuide for Houses offers home energy evaluations by unbiased, qualified and licensed service providers in communities across Canada. Technicians use their expertise in combination with energy modelling software to prepare a report to help the homeowner plan for energy efficiency renovations to an existing house or to make informed decisions while choosing energy upgrades before building a new home. The report includes an EnerGuide for Houses label and rating. Visit our Web site at energuideforhouses.gc.ca.

All About Gas Fireplaces

Rev. ed.

Canadian Cataloguing in Publication Data

The National Library of Canada has catalogued this publication as follows:

All About Gas Fireplaces

(Home Heating and Cooling Series)

Issued also in French under the title: Le guide complet des foyers à gaz

ISBN 0-662-35058-8

Cat. No. M91-23/9-2003E

1. Fireplaces -- Handbooks, manuals, etc.
2. Dwellings -- Heating and ventilation -- Handbooks, manuals, etc.
3. Dwellings -- Energy conservation.
 - I. Canada. Natural Resources Canada.
 - II. Series.

TH7434.A45 1997 697'.1 C97.980356-X

© Her Majesty the Queen in Right of Canada, 2004

Revised March 2004

Aussi disponible en français sous le titre :

Le guide complet des foyers à gaz

To obtain additional copies of this or other free publications on energy efficiency, please contact

Energy Publications
Office of Energy Efficiency
Natural Resources Canada
c/o S.J.D.S.
Ottawa ON K1G 6S3
Tel.: 1 800 387-2000 (toll-free)
Fax: (819) 779-2833
In the National Capital Region, call 995-2943.

You can also view or order several of the Office of Energy Efficiency's publications on-line. Visit our Web site at oee.nrcan.gc.ca/infosource. The Office of Energy Efficiency's Web site is at oee.nrcan.gc.ca.



Recycled paper



Contents

Chapter 1	A Special Place in the Home	2
Chapter 2	Gas Fireplaces and the Environment . . .	4
Chapter 3	What to Look For	4
	Types of gas fireplaces	5
	Types of venting	6
	Efficiency ratings	9
	The new EnerGuide Fireplace Efficiency (FE) rating	10
	Input and output ratings	12
	Electronic or intermittent ignition vs. continuous pilot lights	13
	Variable-setting controls and thermostats	14
	Heat exchange and transfer	15
Chapter 4	Locating a Fireplace for Maximum Benefit	17
Chapter 5	Summary of Features to Look for in an Energy-Efficient Gas Fireplace	21
Chapter 6	Gas “Logs” Not Recommended	23
Chapter 7	What to Avoid	23
Chapter 8	Installing Your Gas Fireplace	24
Chapter 9	Safety Tips for Operating Your Gas Fireplace	25
Chapter 10	Using Your Gas Fireplace Efficiently . .	26
Chapter 11	For More Information	27
Appendix	Determining How a Gas Fireplace Will Affect Your Heating Bill	30

1. A Special Place in the Home

Fireplaces have long held a special place in the hearts of Canadians. At one time an essential source of heat for warmth and cooking, they remain a gathering spot for family and friends, a symbol of romanticism and comfort, and a visually attractive addition to many homes.

Fireplaces are so popular that, in most parts of Canada, it is difficult to sell a new or existing home without one.

However, changes in the way houses are built and renovated have made most contemporary homes incompatible with conventional wood-burning fireplaces. Most notably, the increased insulation and improved airtightness of today's homes run counter to the large amounts of air required by conventional wood fireplaces. Such fireplaces are also extremely inefficient (many actually cause heat loss from the home) and produce high levels of harmful emissions, which pollute outdoor air and can have dangerous effects on indoor air quality.

Yet everyone wants a fireplace! What can be done?

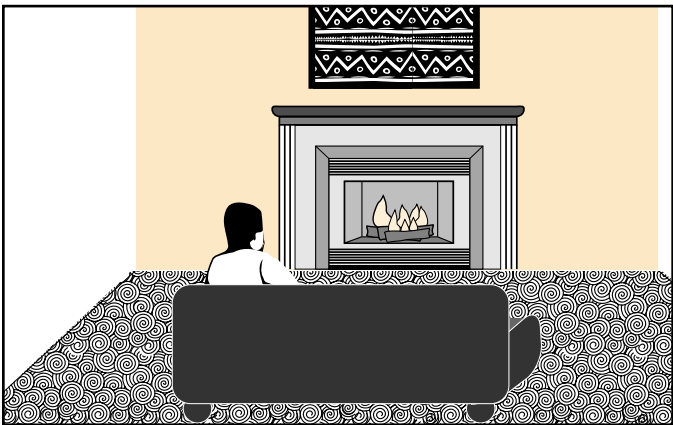

The good news is that some new fireplace designs offer a safe, energy-efficient and environmentally friendly alternative to conventional wood fireplaces. One option is an advanced combustion wood-burning fireplace, as described in *All About Wood Fireplaces*, a free publication also available from Natural Resources Canada's Office of Energy Efficiency.

A second option that is becoming popular across North America – a well-designed and energy-efficient gas fireplace – is the subject of this booklet. In both cases, the new designs can be installed as a completely new fireplace or as a conversion of an existing wood fireplace.

Gas fireplaces have increased in popularity over the past few years. For many homeowners, the attraction of owning a gas fireplace lies in the following:

- the convenience of an on/off switch and an ever-present fuel supply
- the cleanliness factor (gas fireplaces generate no mess in terms of ashes, wood chips, bark, etc.)
- the elimination of chimney cleaning
- the safety of sealed combustion units, which offer little chance for toxic combustion gases to spill into the room
- the environmental benefits as compared with those of a conventional wood fireplace

Although gas fireplaces have been around for a few years, many homeowners disliked their “fake-looking,” uninteresting flames. To counteract this negative perception of gas fireplaces, manufacturers have devoted much effort to producing a yellow flame that more closely resembles the flame of a wood-burning fireplace, yet is still clean-burning. As well, other aesthetic improvements have made gas fireplaces much more appealing to homeowners.

However, not all gas fireplaces are created equal. Some designs are extremely efficient, safe to operate and provide a lot of heat. Others can be very inefficient, and vent-free technology can cause indoor air-quality problems.

It pays to be an informed consumer. By knowing what to look for and what to avoid, you can select a gas fireplace that will suit your home’s decor, contribute to its heating needs and give you peace of mind.

This booklet can help. It explains what you should look for in a safe, energy-efficient gas fireplace as well as the problems that can be encountered with certain technologies. By spending a few minutes reading this booklet now, you can save yourself money down the road in reduced energy costs, both for operating the fireplace and for heating your home, while enjoying the benefits of an attractive fire.

The information in this booklet applies to both natural gas and propane fireplaces. Many manufacturers sell the same basic fireplace for both fuels, with only minor changes to the burner system.

2. Gas Fireplaces and the Environment

Gas fireplaces are noted for their clean-burning characteristics. Compared with wood fireplaces, natural gas and propane fireplaces produce much less carbon monoxide and particulate emissions.

However, no energy source is completely environmentally friendly. Natural gas and propane do release some pollutants when burned, primarily nitrogen oxides (which contribute to ground-level ozone, or smog) and carbon dioxide (a greenhouse gas). They also release significant amounts of moisture into the air. A poorly adjusted gas fireplace can generate incomplete combustion products, including carbon monoxide.

As with other energy-using appliances, it is important to keep in mind that buying an energy-efficient gas fireplace and using it wisely will use less energy and reduce greenhouse gas emissions that contribute to climate change.

3. What to Look For

In recent years, a great deal of effort has gone into making good gas fireplaces. Some excellent units are available that offer a visually attractive flame, are very efficient and can save energy in your home. The key features and

terminology you will come across when shopping for a gas fireplace are discussed in the following.

Types of gas fireplaces

Three basic types of gas fireplaces are widely available in Canada: inserts, factory-built fireplaces (zero-clearance units) and free-standing designs. Your biggest challenge will be sorting through the wide range of models available to select a unit that is as efficient as possible and that suits your particular needs.

Inserts are used to convert existing wood-burning masonry or factory-built metal fireplaces to gas. The gas burner and simulated logs are contained in a special metal housing that fits into the existing fireplace cavity. The unit has a glass front for viewing and a decorative

Figure 2. Zero-Clearance Direct-Vent Gas Fireplace

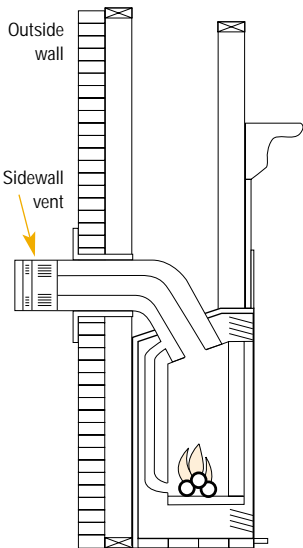
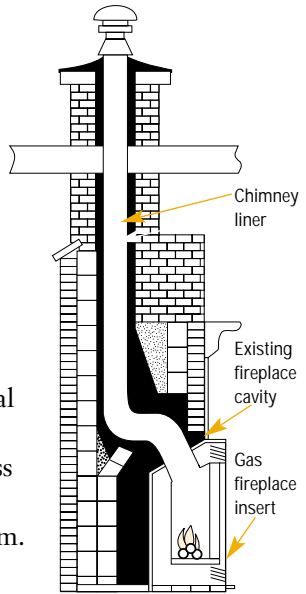

Figure 1. Gas Fireplace Insert in Existing Wood-Burning Fireplace



metal trim. Existing chimneys must be relined with an approved vent when a gas insert is installed.

Zero-clearance gas fireplaces are used in installations where there is no existing fireplace (i.e., during new home construction or as part of a renovation project). The simulated logs and burner are inside their own firebox, around which is an inner and outer shell. This type of gas fireplace can be installed inside the house

envelope, even against an outside wall. The manufacturer's instructions must be followed carefully to ensure proper clearances from combustibles and that approved venting materials are used.

Free-standing gas fireplaces typically resemble some of the new wood-burning stoves. These units tend to be more effective in supplying heat to the house, since all of the fireplace's surfaces are exposed to the room.

The glass fronts used on all of these gas fireplaces can be manufactured from tempered or ceramic glass. Ceramic glass is slightly better at transmitting infrared heat into the room. However, its principal benefit is that it can better withstand higher temperatures associated with sealed units.

Types of venting

Venting is required to remove combustion gases from the firebox to the outdoors. Three options are available: natural draft venting, power venting and direct venting.

Many of the gas fireplaces sold today evacuate combustion products using a vertical chimney (gas vent), which takes advantage of the natural draft caused by the temperature of the flame (hot air rises). These units have a draft hood that requires extra house air to isolate the burner from outside pressure fluctuations (see Figures 4 and 5).

Figure 3. Free-Standing Gas Fireplace

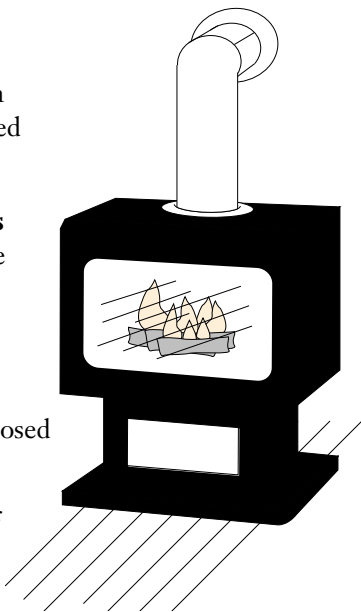

Figure 4. Natural Draft Fireplace with Type A Draft Hood

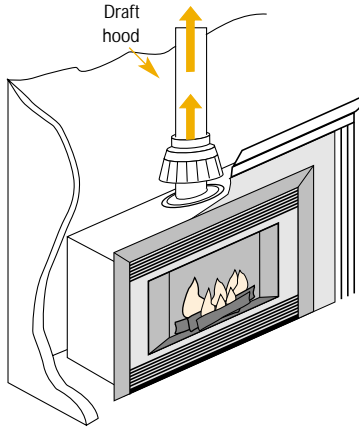
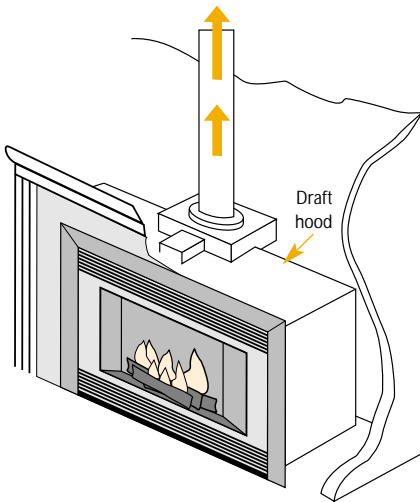

Figure 5. Natural Draft Fireplace with Type B Draft Hood



Natural draft fireplaces typically use a B-vent or, in an existing chimney, an approved metal liner that includes a B-vent or a flexible metal liner.

Some gas fireplaces feature **power venting**, in which an electrical fan assists the venting process. Power venting allows units to be vented with horizontal and vertical flues from locations in a home where a conventional flue cannot be installed. Although power venting is not yet common, it can improve a fireplace's efficiency and will use less house air, as a draft hood is not usually required.

With a **direct-vent** fireplace,

Figure 6. Sidewall Venting of a Direct-Vent Gas Fireplace

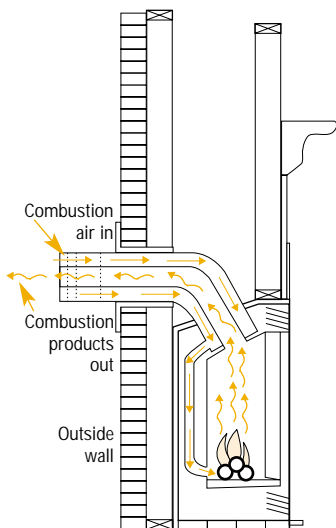

outdoor combustion air is drawn directly into the firebox through one pipe, while combustion products are exhausted through another. The units are sealed, so there is no room air required for combustion and no loss of heated room air to the outdoors. Direct-vent fireplaces are typically installed on an outside wall, with the vent running directly through the wall, although some models are approved for extended horizontal and vertical flues.

Venting may be either **coaxial** or **collinear**, as

illustrated in Figures 7 and 8. Coaxial venting uses two concentric pipes. The outer pipe brings combustion air in from the outdoors, and the inner pipe exhausts the combustion products. This is the method commonly used for sidewall venting. Collinear venting uses two completely separate pipes: one to supply outside combustion air and the other to exhaust combustion products. This method is most often used where there are space limitations when an existing fireplace and chimney have been retrofitted with a gas insert or where long vent distances and cold temperatures make condensation and vent icing a potential concern.

To be installed in an energy-efficient R-2000* home, a gas fireplace must be either direct-vented (sealed) or power-vented. This provides an additional level of protection against spillage of combustion products and helps increase the appliance's efficiency.

* R-2000 is an official mark of Natural Resources Canada.

Figure 7. Direct-Vent Gas Fireplace with a Vertical Coaxial Vent

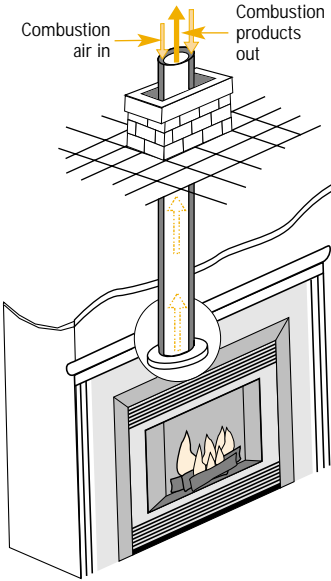
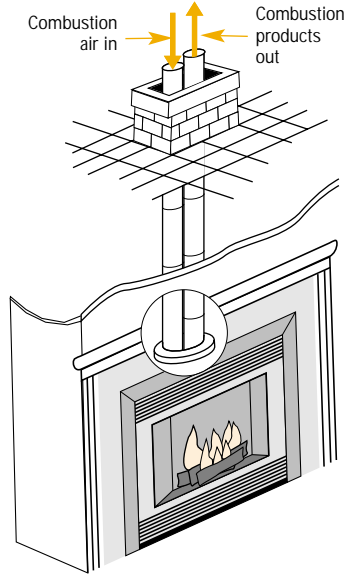

Figure 8. Direct-Vent Gas Fireplace with a Vertical Collinear Vent



Efficiency ratings

When purchasing a gas fireplace, ask about its efficiency first. However, a word of caution is necessary: many different methods have been used to measure the efficiency of gas fireplaces, some of which can give misleading results.

Until recently, most efficiency ratings were steady-state measurements – the maximum efficiency the fireplace could achieve operating under controlled laboratory conditions and after running at equilibrium for a long period of time. This measurement does not take into account many of the ways in which heat loss occurs in a fireplace. A steady-state rating is comparable to the good gas mileage a car achieves when cruising on the highway, as opposed to the much lower mileage you get in start-and-stop city driving. With a gas fireplace, the actual operating efficiency of the unit once it is installed in your home will be lower than the steady-state efficiency – in some cases, much lower.

The new EnerGuide Fireplace Efficiency (FE) rating

The best way to determine the efficiency of a gas fireplace is to ask for its **Fireplace Efficiency rating** based on the CSA-P.4 test method. Tests using this Canadian standard for measuring annual fireplace efficiency have shown that some units operated in the 30 percent range, while the better units ranged from 50 percent to 70 percent.

As of September 2003, an agreement between the Government of Canada and the Heating, Refrigeration and Air Conditioning Institute of Canada (HRAI) established an energy efficiency rating system for vented gas fireplaces. The EnerGuide rating system provides consumers with the assurance of a standardized method of testing, allowing them to accurately compare different makes and models. The testing provides a Fireplace Efficiency (FE) rating based on products tested and certified to the Canadian Standards Association (CSA) test standard P.4.1-02.

The standard assesses all gas fireplaces, whether they are decorative units or are used for space heating. It is an accurate measurement that reflects the overall operation of the fireplace, taking into account its use and performance throughout the entire heating season. The FE rating is expressed as a percentage; therefore, the higher the rating, the more efficient the unit. The FE appears on the EnerGuide label and is presented in one of two ways, depending on whether the product literature lists only a single model or multiple models.

The EnerGuide label for gas fireplaces

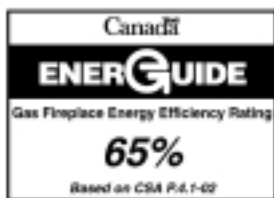

This EnerGuide label with the vented gas fireplace FE rating is shown on manufacturers' product literature that features a single model. As noted in the rating system explanation in the preceding, the higher the percentage, the more efficient the model.

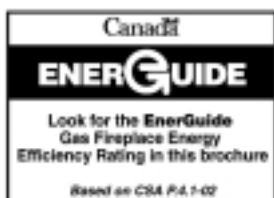

This label is featured in product literature where multiple models with different FE ratings are shown. Each model number listed in the literature will identify the EnerGuide FE rating directly beside the model number. Note that both labels show the statement "Based on CSA P.4.1-02." This statement demonstrates that the FE rating is based on the testing method that all gas fireplaces sold in Canada must adhere to.

Energy efficiency considerations

Gas fireplaces are becoming popular, both for new homes and for replacement of units in existing dwellings. Most units are built-in, whereas others are free-standing and resemble a wood stove. If you are looking for a gas fireplace, consider its particular application: Are you looking for a decorative appliance or a heating appliance? Is the unit the right size for the space, or are there supplemental ways to help move the heat to other areas of the home? Do you understand the difference between zone heating and central heating?

Consider these points:

- Every make and model has an EnerGuide rating, not just the most efficient ones.
- Vented gas fireplaces can look attractive and still be energy efficient.
- The EnerGuide label provides an FE number – the higher the number, the better the efficiency.
- Higher-efficiency equipment saves energy. The actual saving depends on location (i.e., the regional climate and cost of fuel), the efficiency of the vented gas fireplace and the efficiency of the house itself.
- Be careful when comparing the different ratings for appliances that are classed as “decorative” and “heater.”

EnerGuide gas fireplaces directory

A directory of gas fireplaces will be made available to Canadian consumers by fall 2004. The directory will enable you to compare the energy performance and operating costs of similar models.

Input and output ratings

A gas fireplace’s input rating is the amount of fuel energy the fireplace can consume in one hour. The output rating is the amount of heat supplied by the fireplace to the house. Both ratings are usually expressed in British thermal units per hour (Btu/h) or in gigajoules per hour (GJ/h).

A high input rating does not guarantee high heat output; heat output depends both on gas input and on the fireplace’s efficiency. A high-efficiency fireplace burns much less gas in order to supply the same amount of heat compared with a low-efficiency fireplace. For example, a 20 000 Btu/h fireplace operating at 70 percent efficiency will provide the same amount of heat as a 40 000 Btu/h unit operating at 35 percent efficiency – and it will use only half the fuel in doing so!

Heat output, not input, is the important indicator when determining the proper size of appliance for your needs. Remember that a bigger fireplace is not necessarily better. Take into consideration your home's overall heating demand as well as the area where the fireplace will be installed, and select a unit that will match your needs. In a small room, a fireplace with a high output rating could be overpowering and cause overheating and discomfort, rather than cosiness. It will also consume more fuel than necessary to heat the room. A common problem is oversizing the fireplace for the application. **A fireplace with a lower output is the obvious solution.** A fireplace that allows you to “dial down” the input considerably through modulation or turndown, or that has some means of moving heat out of the room to other parts of the house, will allow for greater control of heat output to prevent overheating.

Electronic or intermittent ignition vs. continuous pilot lights

In many gas fireplaces, a pilot light ignites the main burner as the unit is turned on. A pilot light is a small gas flame that, on its own, can consume from 600 to 1500 Btu of gas per hour and, if left to run continuously, can significantly increase your annual energy costs. You will save energy and money by turning off the pilot light when the fireplace is not being used, especially during the summer, but also when the fireplace is not in frequent use during the heating season.

Other fireplaces have an automatic starter, such as an electronic ignition or another type of intermittent ignition device, that eliminates the need for a continuous pilot by restarting gas combustion each time a flame is desired. When purchasing a gas fireplace, consider one that does not have a continuous pilot light.

Some homeowners prefer a fireplace with a continuous pilot light because it gives them an auxiliary heat source that is not dependent on electricity (i.e., the fireplace will operate even when there is a power failure). If this is your preference, look for a unit with a simple method for

shutting off the pilot and a similarly convenient and safe means of relighting the pilot. Do not confuse this feature with most remote control or wall-mounted switches, which often control the main gas flame while leaving the pilot to run continuously.

Figure 9. Gas Fireplace with Pilot Light

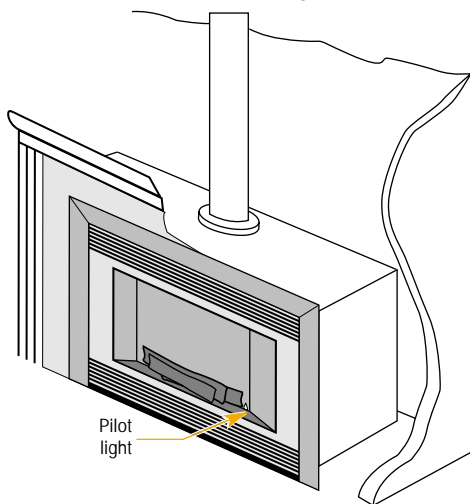

Variable-setting controls and thermostats

A variable-setting control, which allows you to adjust heat output by regulating the fireplace's rate of gas consumption, is another energy-saving feature to look for when purchasing a gas fireplace. This feature, also known as turndown, enables you to maintain better comfort levels, prevent overheating and still have a flame for viewing. At the same time, you may use less fuel by avoiding much of the energy loss that results when a fireplace repeatedly cycles on and off.

Look for a model that has a wide turndown range. Some gas fireplaces allow you a small turndown to only 70 percent of full load (for a 30 000 Btu/h fireplace, this means being able to reduce gas consumption to 21 000 Btu/h). Other models will allow you to go as low as 20 percent of full load (or down to 6000 Btu/h for a 30 000 Btu/h fireplace).

Some fireplaces can be connected to a certain amount of ductwork (much like a furnace), which can help distribute heat to more remote areas of the home while preventing overheating of the room in which the fireplace is installed.

Many gas fireplaces also offer automatic thermostat controls, which help keep the room temperature at a more constant level by automatically adjusting the firing rate. On efficient fireplaces that have a wide turndown range, this thermostat feature can reduce energy consumption while maintaining comfort and continuous viewing pleasure. However, on units that operate at one setting only or that have a limited turndown capability, the thermostat may end up turning the fireplace on and off frequently, which may affect your enjoyment of the flame and can even waste energy.

Heat exchange and transfer

An important factor to consider when purchasing a gas fireplace is the unit's heat-exchange capabilities. Gas fireplaces transfer heat to the house by two primary means: radiation and convection.

Radiation is the transfer of heat from flames and hot surfaces to solid objects, such as furniture, walls and people, that are in the direct path of the heat source by means of infrared radiation. The hotter the source and the greater its ability to emit heat, the better the radiant heat transfer. Radiant heat allows people to feel warm, even when the air around them may be cool. In other words, when you can see the flame, you can be comfortably warmed by radiant heat. This capability distinguishes fireplaces from many other heat sources, including central furnaces.

A factor worth considering is fireplace surface area and exposure. The more a unit's surface is exposed to a room, the more readily it gives up heat by radiation and convection. For this reason, free-standing and hearth-mounted fireplaces that protrude from the wall tend to have higher efficiencies.

Figure 10. Convection and Radiant Heat

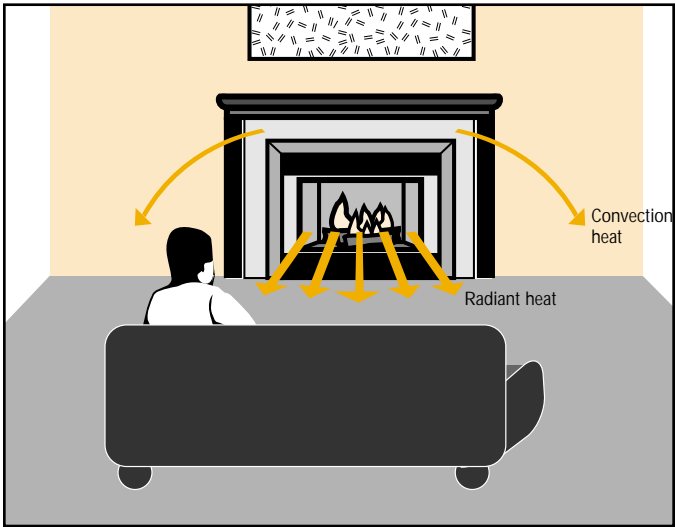

A well-designed fireplace will have channels around and behind the combustion chamber, through which room air will naturally circulate by convection. This is a process of heat transfer where the cool room air picks up heat energy from the fireplace surface causing air currents that transport heat throughout the room. In addition to relying on convection, some units have a heat exchanger that extracts more heat from the combustion gases and transfers it to the house. Fireplaces that have this feature, known as secondary heat exchange, will usually be more efficient than those that do not.

Variable-speed fireplace fans can increase the amount of convective heat supplied by a fireplace by forcing heat into the room. These fans also improve the circulation of air throughout the room. Look for quiet fans that won't take away from your enjoyment of the fire. A ceiling fan can improve circulation of the heated air from a fireplace and pull the more buoyant hot air down from the ceiling.

4. Locating a Fireplace for Maximum Benefit

If your home-building or renovation plans include an efficient gas fireplace, take some time to plan the installation so that the fireplace can effectively contribute to your heating needs.

An efficient gas fireplace can lower a home's overall energy consumption and heating bills when located in a major living area where the heat has access to other parts of the house.

Install the fireplace in a part of the house where it will be visually attractive and where you and your family spend most of your time and will benefit the most from its warmth. This is usually on the main floor, in your family room, dining room, living room or kitchen.

The layout of your house will affect the fireplace's ability to provide heat to other areas of the house. If you are building a new home, consider a layout that focuses on the fireplace. An open design, where there are few walls to separate rooms on the main floor, will allow heat to move from the fireplace

Figure 11. Open Design Concept with Direct-Vent Fireplace on Outside Wall

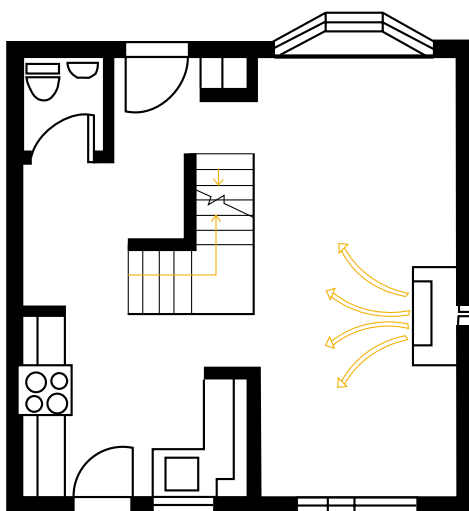

area to other rooms (see Figure 11). An accessible stairwell will also allow the heat to move upstairs (see Figure 12).

Efficient natural gas fireplaces can be an effective means of lowering heating costs and improving comfort levels in homes heated by electric baseboards. The baseboards in remote rooms can keep those areas at acceptable temperatures, effectively “zoning” the house, with the gas fireplace providing most of the “comfort” heat for the rest of the home. A properly located and well-designed fireplace can meet over half the conventional-heating demands of a standard house while providing a visually appealing and comfortable atmosphere.

If your house’s layout is such that the best location for a fireplace is against an outside wall, try to build the fireplace inside the house envelope. If this cannot be done, look for a fireplace with an insulated outer casing. Insulation is also important for a gas fireplace insert that is installed in an existing outside wall fireplace in order to eliminate direct heat loss from the fireplace through an outside wall.

Figure 12. Open House Design Showing Heated Air Circulation from Gas Fireplace

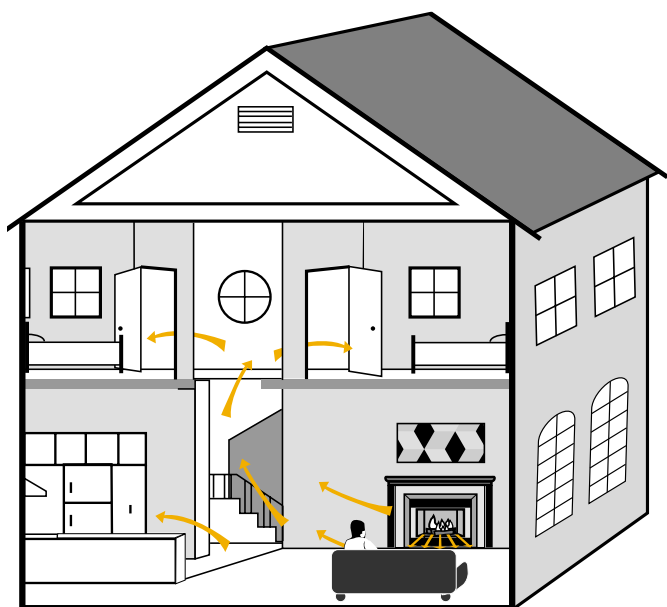

Another option to minimize heat loss is to locate the fireplace and chimney on an inside wall. By surrounding the vent with warm rather than cold air, you ensure better draft and reduce the chances of the house becoming a better chimney than the chimney itself (see sidebar on page 20).

If you must install a gas fireplace in the basement, a direct-vent unit is likely your best bet since it does not require a chimney. A direct-vent fireplace can be exhausted out the side wall of the house above the foundation, and it is sealed to prevent combustion exhaust spillage or the robbing of air for combustion from the furnace or water heater. Seriously consider insulating the basement before you install a fireplace there. As it will be more difficult to distribute heat, consider a low-input fireplace or a unit that can have ducts to transfer the heat elsewhere.

The house as a chimney

An operating chimney is an enclosed column of warm air or gases surrounded by colder outside air. The warm air or gas in the chimney is more buoyant than the dense, cold outside air, so it rises, producing natural vertical draft in the system.

In the winter, your house is also an enclosed column of warm, buoyant air that creates its own form of draft. In effect, the warm air pushes upward, creating higher air pressure at the top of the house and lower pressure in the lower levels of the house.

When an unsealed (non-direct-vent) gas fireplace has been installed in a home that has a lower pressure than outside, the house can become a more effective chimney than the fireplace chimney itself – especially if the chimney is located on an outside wall. Rather than using the chimney to release combustion gases to the outdoors, air can be drawn back under negative pressure into the home through the chimney. This reverse flow of air can cause spillage of combustion gases from a fireplace or other combustion appliances into the home, creating hazardous indoor air-quality problems.

5. Summary of Features to Look for in an Energy-Efficient Gas Fireplace

When shopping for an energy-efficient gas fireplace, ask for the EnerGuide Fireplace Efficiency (FE) ratings of the fireplaces you are interested in. Using this information, narrow your choices to the fireplaces that have relatively high efficiencies and can supply the kind of heat output needed for the location you have chosen.

The most energy-efficient gas fireplaces have many of the following features:

- a high EnerGuide Fireplace Efficiency (FE) rating as tested to CSA P.4.1-02, found in product brochures or on manufacturers' Web sites
- direct-vent design, where appropriate
- an intermittent electronic ignition system or an easy means of turning off and relighting the pilot light
- a ceramic glass front
- a quiet squirrel-cage-type circulating fan to help transfer convective heat to the room
- secondary heat exchanger
- insulated outer casing to prevent heat loss through the walls to the outside if located on an exterior wall
- good turndown or other means such as ducting to prevent localized overheating

Figure 13. Typical Characteristics of an Efficient Direct-Vent Gas Fireplace

1. Ceramic glass
2. Preheated combustion air
3. Coaxial sidewall direct vent
4. Cool room return-air convection inlet
5. Heated air convection outlet
6. Variable speed, squirrel-cage circulating fan
7. Insulated outer casing
8. Convection heat-exchange chamber

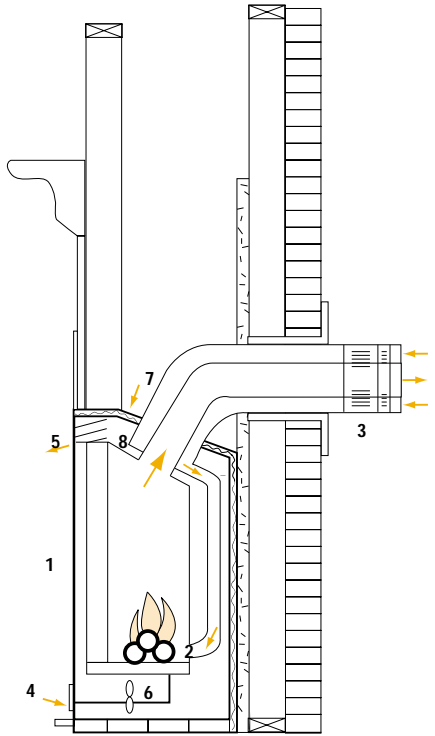

6. Gas “Logs” Not Recommended

In addition to knowing what to look for in an energy-efficient gas fireplace, it is important to know what is not recommended. In the case of gas logs, ceramic “logs” with gas burners are placed directly into an existing wood fireplace to give the effect of a burning fire. These gas logs provide no real heat to the house and are essentially a waste of energy and money, as well as a potential source of pollutants, although they can provide an attractive fire.

Gas logs can also cause venting system problems, particularly in colder regions. This is primarily because wood fireplace chimneys are not designed to handle the low-temperature, low-flow, high-moisture flue gases. If a wood fireplace chimney is not relined to accommodate these gases, the chances of flue gas condensation and chimney deterioration are high. As well, if the fireplace is on an outside wall, there is a risk that the gas burners will not generate enough heat to create a good draft. Under these conditions, the house can become a better chimney than the chimney itself (see sidebar on page 20), disrupting the flame and drawing carbon monoxide and other combustion products back into the living area.

7. What to Avoid

A type of gas fireplace to avoid in Canadian housing – the vent-free gas fireplace – is available in the United States. As the name implies, these units do not vent to the outdoors; all the combustion gases (including carbon monoxide, carbon dioxide, nitrogen oxides and large amounts of water vapour) are released directly into the house. These fireplaces can cause serious indoor air-quality and moisture problems, particularly in airtight Canadian homes. They are not approved for use in Canada.

8. Installing Your Gas Fireplace

Having chosen a good location for your efficient gas fireplace, you should ensure that it is installed by a qualified technician. In most areas, a special installation permit is required before you begin, as well as an inspection once the work is completed. Check with the dealer, your municipality or your gas utility for details. You should also inform your insurance company.

Some dealers offer full installation services. Independent, qualified contractors also install this equipment. Make sure to get several estimates. When you are comparing the estimates, take into account the contractor's knowledge and experience, as well as the materials to be used.

Estimates should include the following:

- an itemized list of all labour and material costs included in the estimate, as well as the total cost for all necessary work
- a statement that clearly defines who is responsible for
 - all necessary permits and the payment of related fees
 - on-site inspections by the utility and/or other local authority
 - the scheduling of work that must be done by the utility, such as supply pipe installation and hookup
- a clear indication of when the work will be completed
- a warranty for materials and labour
- a schedule and method of payment

Ask each contractor for the names of homeowners for whom they have installed similar fireplaces, and contact these references. It is also a good idea to check with the Better Business Bureau to see if complaints have been filed on any of the companies you are considering.

Finally, do not hesitate to ask the installer for a clear explanation of any aspect of the work before, during or after the installation of your gas fireplace.

9. Safety Tips for Operating Your Gas Fireplace

- If your fireplace is installed in a home during construction or renovation, do not operate it until the area is thoroughly cleaned. Drywall dust and other contaminants can harm the fan, motors and burners.
- Check the manufacturer's instructions before adding or modifying a mantle or surround (minimum clearances are required).
- Have your fireplace inspected before its initial use – and continue to have it serviced on a regular basis.
- Carefully read the manufacturer's instructions before operating the fireplace for the first time.
- Keep combustibles away from hot surfaces during operation.
- If the pilot light or flame goes out, wait five minutes or longer (see the manufacturer's instructions) before attempting to relight the fireplace. This allows time to clear the fireplace of gas and is particularly important with direct-vent models.
- Be alert for unusual odours or flames, which are often a sign that the fireplace is not operating properly. In such cases, contact your dealer for servicing. Contact the gas company if you smell gas.
- Make sure that air-circulating passageways and fans are kept clean and free from obstruction.
- Wait for the unit to cool completely before wiping the glass with a damp cloth (otherwise, you can cause thermal stress and breakage).

- If the glass breaks, have a qualified service technician replace it with glass supplied by the manufacturer.
- With sidewall-exhausting, direct-vent units, keep the external vent clear of debris and snow at all times, and maintain the manufacturer's minimum clearances between the vent and fences, shrubs and walkways, etc.
- If you do not have a sealed direct-vent fireplace, consider installing a carbon monoxide detector near the fireplace. These devices continually monitor the air for carbon monoxide and sound an alarm when high levels are detected, just as a smoke detector will signal the possible existence of a fire (all Canadian homes should already be properly equipped with smoke detectors). If your carbon monoxide detector goes off, open the windows, shut the fireplace off and leave the house immediately. If anyone experiences headaches, extreme lethargy or nausea during such an occurrence, he or she should immediately seek medical treatment. It is also critical that you determine the source and cause of the high carbon monoxide levels and have the situation remedied by a professional.

10. Using Your Gas Fireplace Efficiently

Purchasing an energy-efficient gas fireplace and properly locating and installing it are critical first steps in controlling your fireplace's operating costs and helping the environment. However, it is also important to use the fireplace wisely once it is installed. Follow these basic guidelines to maximize your fireplace's performance and minimize its energy consumption.

- If you buy a unit with a pilot light, make sure that you turn off the pilot light during the summer and during the heating season when you are not frequently using your fireplace. Follow the manufacturer's instructions carefully when relighting.
- When the fireplace is operating, turn down your home's main thermostat whenever possible.

- If the fireplace has a thermostat, keep it at the lowest setting possible for an acceptable comfort level – turn it down when you are not using it (otherwise the thermostat could cycle the fireplace on even when the room is not being used or when no one is home).
- Keep the glass clean to maximize radiant heat transfer.

Remember that a well-designed, energy-efficient gas fireplace, properly located and maintained, can give you hours of pleasure and comfort while reducing your overall heating bill.

11. FOR MORE INFORMATION

ENERGY EFFICIENCY HOUSING RETROFITS

Consider getting expert advice with an EnerGuide for Houses evaluation. The service provides homeowners with a home energy efficiency evaluation service, complete with an air-leakage test, a written recommendation report and an EnerGuide rating. It will help you plan energy efficiency upgrades that can easily and cost-effectively be incorporated into most renovation projects, resulting in a more comfortable home that uses less energy. For additional information or to obtain the name of a delivery agent in your area, visit the Web site at energiguideforhouses.gc.ca, or call Natural Resources Canada toll-free at 1 800 387-2000 or (613) 995-2943 in the National Capital Region.

ORDER FREE PUBLICATIONS FROM THE OEE

The Office of Energy Efficiency (OEE) of Natural Resources Canada offers many publications that will help you understand home heating systems, home energy use and transportation efficiency. These publications explain what you can do to reduce your energy use and maintenance costs while increasing your comfort and helping to protect the environment.

ENERGUIDE FOR RENOVATING YOUR HOME

Keeping the Heat In is a guide to all aspects of home insulation and draftproofing. Whether you plan to do it

yourself or hire a contractor, this 134-page book can help make it easier. Fact sheets are also available on air-leakage control, improving window energy efficiency and moisture problems. Consider getting the expert unbiased advice of an EnerGuide for Houses evaluation before you renovate. Our telephone operators can give you contact information for advisors in your local area.

ENERGUIDE FOR HOME HEATING AND COOLING

If you are interested in a particular energy source, the OEE has booklets on heating with electricity, gas, oil, heat pumps and wood. Other publications are available on heat recovery ventilators, wood fireplaces, gas fireplaces, air conditioning your home and comparing home heating systems.

ENERGUIDE FOR CHOOSING THE MOST ENERGY-EFFICIENT PRODUCTS

The EnerGuide label, which is affixed to all new major electrical household appliances and room air conditioners, helps you compare the energy ratings of all models sold in Canada. EnerGuide ratings are also listed in the OEE's annual directories of major electrical household appliances and room air conditioners.

EVERY NEW HOUSE SHOULD BE THIS GOOD

R-2000 homes are the best built, most comfortable homes in Canada, and they use up to 50 percent less energy than conventional dwellings. R-2000 homes feature state-of-the-art heating systems, high levels of insulation and whole-house ventilation systems that provide continuous fresh air to all rooms. Subject to quality assurance checks during the construction process, once completed, R-2000 homes are certified as being energy efficient.

BUYING, DRIVING AND MAINTAINING YOUR CAR

For information on vehicle fuel consumption, look for the EnerGuide label that appears on every new automobile, van and light-duty truck for sale in Canada. It helps you compare different vehicles' city and highway fuel consumption ratings and estimated annual fuel costs. You can also consult the OEE's *Fuel Consumption Guide*,

produced annually, which provides the same information for all vehicles. The OEE's EnerGuide for Vehicles Awards also recognize the vehicles with the lowest fuel consumption in different categories.

Also available is the OEE's *Car Economy Calculator*, a fuel log that helps you calculate your vehicle's fuel consumption and savings.

The AutoSmart Guide, also produced by the OEE, provides detailed fuel efficiency information and offers tips on purchasing, operating and maintaining personal vehicles.

To obtain additional copies of this or other free publications on energy efficiency, please contact

Energy Publications
Office of Energy Efficiency
Natural Resources Canada
c/o S.J.D.S.
Ottawa ON K1G 6S3
Tel.: 1 800 387-2000 (toll-free)
Fax: (819) 779-2833
In the National Capital Region, call 995-2943.

Please allow three weeks for delivery.

Publications can also be ordered or viewed on-line at oee.nrcan.gc.ca/infosource.

Appendix

Determining How a Gas Fireplace Will Affect Your Heating Bill

Step 1: Determine the price of different energy sources in your area

Call your local electric utility or natural gas, propane or oil dealer to determine the cost of energy sources in your area. Be sure to get the prices for the energy sources in the same units as used in Table 1. Write the costs in the spaces provided. (Information from Table 1 will be used in Step 4 to calculate your home's annual heating costs.) If your local gas price is given in gigajoules (GJ), you can convert it to cubic metres (m³) by multiplying the price per gigajoule by 0.0375. For example:

$$\$5.17/\text{GJ} \times 0.0375 = \$0.19/\text{m}^3$$

Table 1. Energy Content and Local Price of Various Energy Sources

Fuel	Energy Content	Local Energy Cost/Unit
Natural gas	37.5 MJ/m ³	\$0.____ /m ³
Propane	25.3 MJ/L	\$0.____ /L
Electricity	3.6 MJ/kWh	\$0.____ /kWh
Oil	38.2 MJ/L	\$0.____ /L
Hardwood*	30 600 MJ/cord	\$0.____ /cord
Softwood*	18 700 MJ/cord	\$0.____ /cord

Conversions: 1000 MJ = 1 GJ

1 MJ = 947.82 Btu

*The figures provided for wood are for a full cord, measuring 1.2 m × 1.2 m × 2.4 m (4 ft. × 4 ft. × 8 ft.).

megajoules (MJ)

litres (L)

kilowatt-hours (kWh)

British thermal units (Btu)

metres (m)

feet (ft)

gigajoule (GJ)

Step 2: Find the seasonal efficiency of your existing central heating system in Table 2.

Table 2. Typical Heating System Efficiencies

Energy Source	Technology	Seasonal Efficiency (AFUE) %
Natural gas	Conventional Vent damper with non-continuous pilot light	60
	Mid-efficiency	62–67
	High-efficiency	78–84
	condensing furnace	89–97
	Integrated space/tap water condensing	89–96
Propane	Conventional Vent damper with non-continuous pilot light	62
	Mid-efficiency	64–69
	Condensing	79–85
		87–94
Oil	Cast-iron head burner (old furnace)	60
	Flame-retention head replacement burner	70–78
	High-static replacement burner	74–82
	New standard model	78–86
	Mid-efficiency	83–89
	Integrated space/tap water mid-efficiency	83–89
Electricity	Electric baseboards	100
	Electric furnace or boiler	100
	Air-source heat pump	1.7 COP*
	Earth-energy system (ground-source heat pump)	2.6 COP*
Wood	Central furnace	45–55
	Conventional stove (properly located)	55–70
	High-tech stove (properly located)	70–80
	Advanced combustion fireplace	50–70
	Pellet stove	55–80

* COP = Coefficient of performance, a measure of the heat delivered by a heat pump over the heating season per unit of electricity consumed.

Step 3: Determine your home's annual heating load

If you know your bill for space heating and the unit cost of your energy source, you can determine your annual heating load in gigajoules (GJ) from the following equation:

$$\text{Annual Heating Load} = \frac{\text{Heating Bill}}{100\,000} \times \frac{\text{Seasonal Efficiency}}{\text{Energy Cost/Unit}} \times \text{Energy Content}$$

For example, suppose you have been able to determine that your annual space heating bill with natural gas is \$687, and gas costs \$0.22 per m³, and you have an old conventional gas furnace with a seasonal efficiency of 60 percent (from Table 2). From Table 1, energy content of natural gas is 37.5 MJ/m³.

$$\text{Annual Heating Load} = \frac{687}{100\,000} \times \frac{60}{0.22} \times 37.5 = 70 \text{ GJ}$$

If your bills also include tap water heating and even equipment rentals, you still can calculate your annual heating load, but it will require a little more care and calculation to separate out your heating portion.

If you can't consult your heating bills, you can estimate your annual heating load in GJ from Table 3, selecting the house type and location that is closest to your own.

Table 3. Typical Annual Heating Loads in Gigajoules (GJ) for Various Housing Types in Canadian Cities

City	Old Detached	New Detached	New Semi-Detached	New Townhouse
Victoria/Vancouver	85	60	45	30
Prince George	150	110	80	60
Calgary	120	90	65	50
Edmonton	130	95	70	55
Fort McMurray/ Prince Albert	140	105	80	60
Regina/Saskatoon/ Winnipeg	130	90	70	50
Whitehorse	155	115	85	60
Yellowknife	195	145	110	80
Thunder Bay	130	95	70	55
Sudbury	120	90	65	50
Ottawa	110	75	55	40
Toronto	95	65	45	35
Windsor	80	55	40	30
Montréal	110	80	60	45
Québec	115	85	65	50
Chicoutimi	125	90	70	55
Saint John	105	75	60	45
Edmundston	120	90	65	50
Charlottetown	110	80	60	45
Halifax	100	75	55	40
St. John's	120	85	60	45

Note: “New” means houses built in 1990 or later, and “old” means houses built before 1990. Due to construction practices, weatherizing and re-insulating (which can be different from house to house), these figures are meant to be used only as general guidelines; they should not substitute for an accurate heating requirement determination.

Assumptions:

New townhouse – inside unit, approximately 93 m² (1000 sq. ft.)

New semi-detached – approximately 139 m² (1500 sq. ft.)

New detached – approximately 186 m² (2000 sq. ft.)

Old detached – approximately 186 m² (2000 sq. ft.)

Step 4: Use the following equation to estimate heating costs

Once you know the heating load and local energy prices, your home's annual heating costs can be calculated using the following equation:

$$\frac{\text{Energy Cost/Unit}}{\text{Energy Content}} \times \frac{\text{Heating Load}}{\text{Seasonal Efficiency}} \times 100\,000 = \text{Heating Cost (\$)}$$

Step 5: Choose the fireplaces you wish to evaluate

Determine which gas fireplaces you are interested in and obtain their EnerGuide fireplace efficiencies.

Example 1

Assume you have a 12-year-old house that is heated with electric baseboards and you intend to install a gas fireplace to reduce your electricity bills. You have chosen to locate the fireplace in a major living area where its heat will reach other parts of the house.

Your choices are a direct-vent fireplace with 72% efficiency and a natural gas fireplace with 30% efficiency or a similar propane fireplace that operates at 72% or 30% efficiency. Local energy costs are \$0.20/m³ for natural gas, \$0.33/L for propane and \$0.08/kWh for electricity. If your house heating load is 100 GJ per year and you would like to displace 40% of that load with the gas fireplace, what would your costs be relative to the existing electric heat?

Using the formula

$$\frac{\text{Energy Cost/Unit}}{\text{Energy Content}} \times \frac{\text{Heating Load (\%)}}{\text{Seasonal Efficiency (\%)}} \times 100\,000 = \text{Heating Cost (\$)}$$

(see Table 1 on page 30 for energy content values)

The total cost to heat the house electrically at 100% efficiency is

$$\frac{0.08}{3.6} \times \frac{100}{100} \times 100\,000 = \$2,222/\text{year}$$

You wish to displace 40% of the total heat load of 100 GJ, or 40 GJ (40% ÷ 100% × 100 GJ = 40 GJ).

The cost to heat this portion electrically at 100% efficiency is

$$\frac{0.08}{3.6} \times \frac{40}{100} \times 100\,000 = \$889/\text{year}$$

The cost to heat this portion with an efficient (72%) natural gas fireplace is

$$\frac{0.20}{37.5} \times \frac{40}{72} \times 100\,000 = \$296/\text{year}$$

The cost to heat this portion with an inefficient (30%) natural gas fireplace is

$$\frac{0.20}{37.5} \times \frac{40}{30} \times 100\,000 = \$711/\text{year}$$

The cost to heat this portion with an efficient (72%) propane fireplace is

$$\frac{0.33}{25.3} \times \frac{40}{72} \times 100\,000 = \$725/\text{year}$$

The cost to heat this portion with an inefficient (30%) propane fireplace is

$$\frac{0.33}{25.3} \times \frac{40}{30} \times 100\,000 = \$1,739/\text{year}$$

Thus with the efficient direct-vent natural gas fireplace, you could reduce your overall heating costs by as much as \$593/year (\$889 – \$296), or 27% of your current electric heating bill.

With the inefficient natural gas fireplace, your heating costs would still be reduced by \$178/year (\$889 – \$711), or 8% of your total heating bill.

With the efficient direct-vent propane fireplace, your heating costs would be reduced by \$164/year (\$889 – \$725), or 7% of your total heating bill.

By installing the inefficient propane fireplace, your heating costs could be *increased* by \$850 (\$889 – \$1739), or 38% of your total heating bill.

Based on the above calculations, the direct-vent natural gas fireplace with 72% efficiency (when properly located in the house) appears to be an effective way to lower your overall heating costs while providing comfort and aesthetic pleasure.

Table A1. Summary of Calculations from Example 1

Heating Appliance	Energy Cost (\$/unit)	Efficiency (%)	Energy Content (MJ/unit)	Cost to Displace 40% of Heating Load per Year	Savings on Total Current Electric Heating Bill	
					(\$/yr.)	(%)
Electric base-boards	0.08/kWh	100	3.6	\$889	0	(Base)
Natural gas fireplace – 72% efficient	0.20/m ³	72	37.5	\$296	593	27
Natural gas fireplace – 30% efficient	0.20/m ³	30	37.5	\$711	178	8
Propane fireplace – 72% efficient	0.33/L	72	25.3	\$725	164	7
Propane fireplace – 30% efficient	0.33/L	30	25.3	\$1,739	-850	-38

Example 2

Assume you have a small, 25-year-old house heated by a conventional oil furnace and burner and that your oil heating bill for one year is \$870. According to Table 2 on page 31, the seasonal efficiency of this type of oil furnace is 60%. You are considering purchasing a propane fireplace with a seasonal efficiency of 55%. With oil

costing \$0.35/L and propane costing \$0.33/L, what would be the impact on your heating bill if you wanted to displace 20% of oil heating using a fireplace?

First, calculate the amount of oil used during the heating season. To do this, divide the cost of oil per year by the cost per litre, as follows:

$$\frac{870}{0.35} = 2486 \text{ litres}$$

Then, calculate your home's total heating load using the following equation:

$$\frac{\text{Heating Bill}}{100\,000} \times \frac{\text{Seasonal Efficiency}}{\text{Energy Cost/Unit}} \times \text{Energy Content} = \text{Annual Heating Load (GJ)}$$

For the purposes of this example, the result is as follows:

$$\text{Heating load} = \frac{870}{100\,000} \times \frac{60}{0.35} \times 38.2 = 57 \text{ GJ}$$

The amount of heat to be supplied by the propane fireplace is 20% of 57 GJ, or 11.4 GJ.

Now, using the equation for determining a home's heating cost

$$\frac{\text{Energy Cost/Unit}}{\text{Energy Content}} \times \frac{\text{Heating Load}}{\text{Seasonal Efficiency}} \times 100\,000 = \text{Heating Cost (\$)}$$

calculate how much it will cost to provide 20% of the heating load using a propane fireplace with 55% efficiency:

$$20\% \text{ heating cost} = \frac{0.33}{25.3} \times \frac{11.4}{55} \times 100\,000 = \$270$$

Since 20% of your current \$870 oil heating bill amounts to only \$174, it would actually cost you an additional \$96 (\$270 – \$174) per year to displace 20% of your oil heat with the propane fireplace – hardly an incentive for proceeding with the purchase!

Table A2. Summary of Calculations from Example 2

Heating Appliance	Energy Cost (\$/L)	Efficiency (%)	Energy Content (MJ/unit)	Cost to Displace 20% of Heating Load per year	Savings on Total Current Oil Heating Bill	
					(\$/yr.)	(%)
Oil furnace	0.35	60	38.2	\$174	0	(Base)
Propane fireplace – 55% efficient	0.33	55	25.3	\$270	–96	–11

Example 3

Assume you have an eight-year-old house heated by a conventional natural gas furnace that is 60% efficient. You want to install a natural gas fireplace that is 70% efficient. Your total heating load is 80 GJ, and the cost for natural gas in your area is \$0.21 per m³. What would be the impact on your heating bill if you displaced 25% of your central furnace heating with the fireplace?

Using the equation for calculating total heating costs, we learn that it costs \$747 to heat your home using the natural gas furnace:

$$\text{Heating cost} = \frac{0.21}{37.5} \times \frac{80}{60} \times 100\,000 = \$747$$

The amount of heat you want to supply using the fireplace is 25% of 80 GJ, or 20 GJ. The cost of providing this amount of heat with a natural gas fireplace that is 70% efficient is as follows:

$$25\% \text{ heating cost} = \frac{0.21}{37.5} \times \frac{20}{70} \times 100\,000 = \$160$$

Since 25% of your current gas heating bill amounts to \$187, you could reduce your gas bill by \$27 (\$187 – \$160) per year by installing a natural gas fireplace that is 70% efficient.

Table A3. Summary of Calculations from Example 3

Heating Appliance	Energy Cost (\$/m ³)	Efficiency (%)	Energy Content (MJ/unit)	Cost to Displace 25% of Heating Load per Year	Savings on Total Current Gas Heating Bill	
					(\$/yr.)	(%)
Natural gas furnace	0.21	60	37.5	\$187	0	(Base)
Natural gas fireplace -70% efficient	0.21	70	37.5	\$160	160	4

Notes

Notes

Leading Canadians to Energy Efficiency at Home, at Work and on the Road

The Office of Energy Efficiency of Natural Resources Canada strengthens and expands Canada's commitment to energy efficiency in order to help address the challenges of climate change.

Canada